

Panasonic
ideas for life

PT-F200NTU
PT-F200U
LCD Projectors

**Long-Lasting
Brightness**

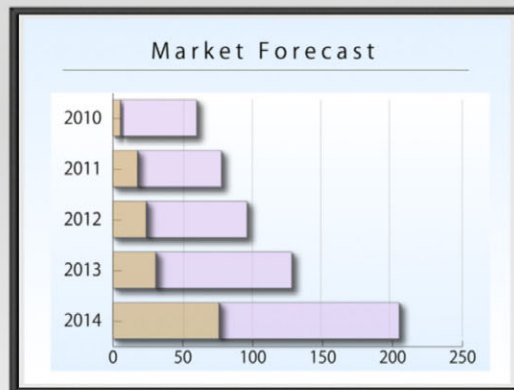



With their outstanding flexibility, PT-F200 series projectors make ideal replacements for existing ceiling-mounted systems. They require little maintenance after installation, so total cost of ownership is low.



A Bright Choice for New Installations and Replacement Use

ADVANCED TECHNOLOGIES THAT MAINTAIN HIGH BRIGHTNESS OVER A LONGER SERVICE LIFE

Auto Rolling Filter (ARF) and Anti-Dust Design

A Micro Cut Filter, a high-efficiency electrostatic filter, with superior dust-collecting performance combines with Panasonic's original Auto Rolling Filter and anti-dust design to minimize brightness loss due to dust accumulation. The projector automatically detects when dust accumulates on the high-efficiency electrostatic filter and impairs performance. The affected section of the filter is wound into the casing, so the filter maintains its dust-catching capability. In developing the anti-dust design, Panasonic totally re-engineered the airflow path, from intake to exhaust, to create a cabinet that hermetically seals off the projector interior. This design and the Auto Rolling Filter team up to keep the air inside the projector dust-free at all times.

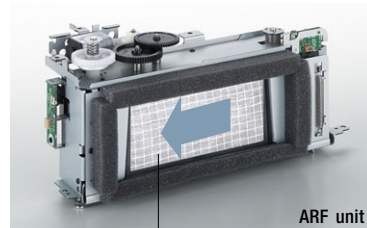

ARF unit



ARF unit

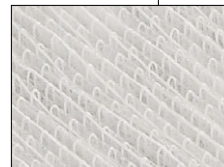

Micro Cut Filter

A high-efficiency electrostatic filter in the air intake section traps dust particles that are 1 microns or larger. By capturing approximately 7 times as much dust as our previous filters, it guards against optical blocks and reduces the penetration of dust into the interior to provide stable operation by preventing drops in brightness.

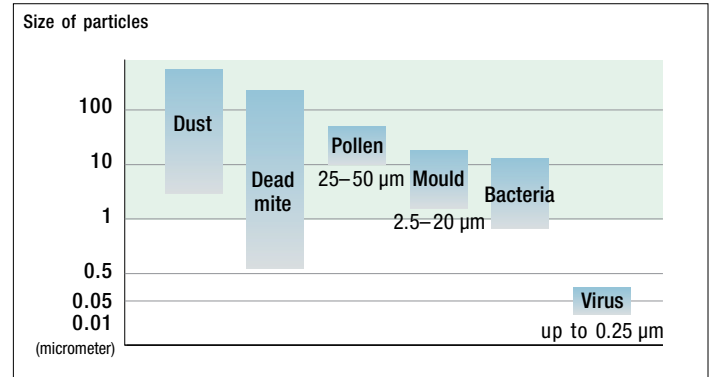

The PT-F200NTU and PT-F200U are high-performance LCD projectors designed for use in fixed installations. Each model combines Panasonic's original Auto Rolling Filter with an original lamp drive system to deliver crisp, bright images over extended periods of time and enable a 5,000-hour*¹ lamp replacement cycle. Each also offers outstanding installation flexibility, with 2x zoom lens, lens shift and wireless/wired LAN*² functions that accommodate everything from permanent ceiling-mounted use to simple placement on a shelf. Whether you're looking to install a new system or considering a replacement, Panasonic answers the call for projectors that provide long-lasting brightness, simple maintenance, and easy, casual use even in fixed installations.

*¹ The value given above does not imply a guaranteed amount of time. The value may vary considerably depending on usage conditions.
*² The PT-F200NTU only.

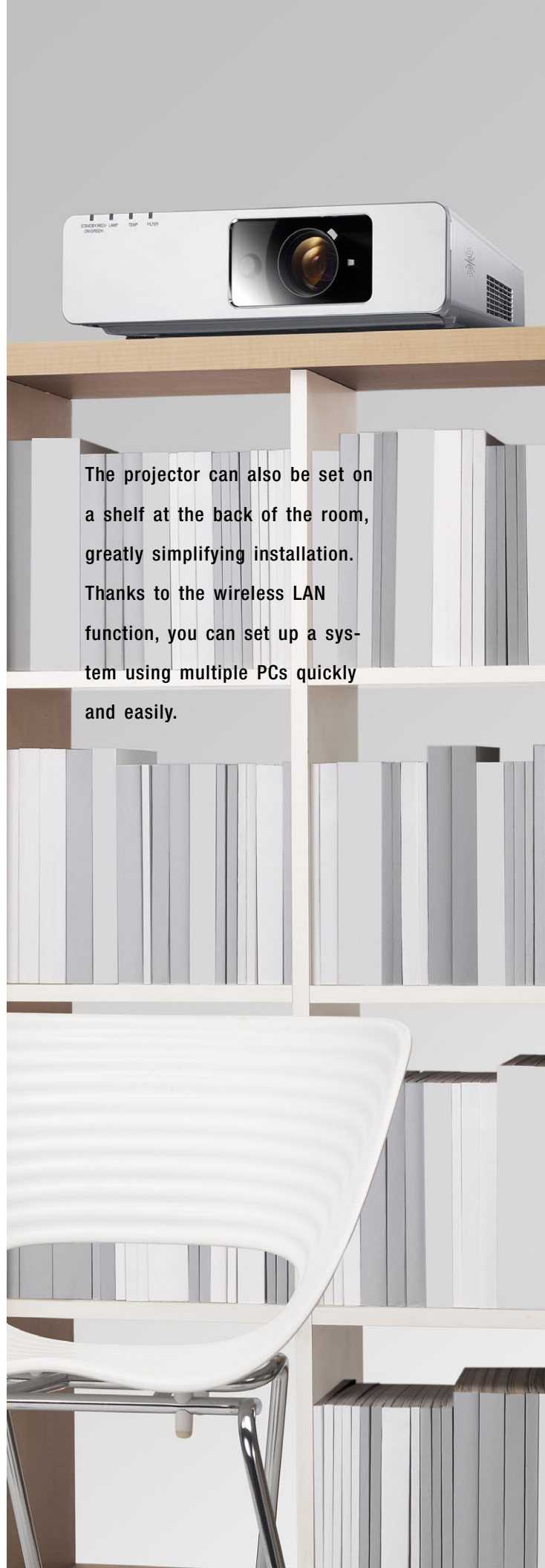

The projector can also be set on a shelf at the back of the room, greatly simplifying installation. Thanks to the wireless LAN function, you can set up a system using multiple PCs quickly and easily.



Original Lamp Drive System for Optimal Lamp Performance

Lamps used in a projector require much higher precision than ordinary household lamps. Panasonic employs a number of new technologies—including an original lamp drive system—that help maintain optimal lamp performance for longer-lasting brightness. This has resulted in a 5,000-hour* lamp replacement cycle.

* The value given above does not imply a guaranteed amount of time. The value may vary considerably depending on usage conditions.

Daylight View 4 Technology: Remarkable Detail with Enhanced Perception of Brightness and Contrast*

The PT-F200 series feature Panasonic's Daylight View 4 technology. Sharp edges are achieved with the new "Edge Enhancer Control" and "Gamma Curve Control." Remarkable detail is provided and perceived brightness and contrast are enhanced, so images appear crisp, vivid, 3-dimensional and easy to see even in brightly lit rooms. Daylight View 4 also includes a built-in ambient light sensor that automatically detects room brightness and adjusts operation accordingly.

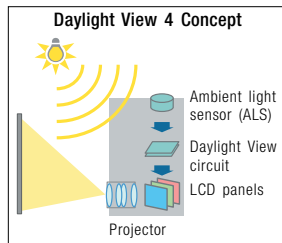

* There is no actual change in the rated brightness or contrast ratio.



Simulated image with Daylight View 4 turned off. Overall contrast appears lower, and images in dark areas are blackened.



Simulated image with Daylight View 4 turned on. Detail, depth, brightness and contrast over the entire image are enhanced.



CONVENIENT FEATURES FOR FIXED INSTALLATION

Wide 2x Zoom and Horizontal/Vertical Lens Shift Give You More Installation Flexibility

Each can project a 120-inch image (diagonal) from any distance between 11.8 feet (3.6 m) and 23.6 feet (7.2 m). In new installa-

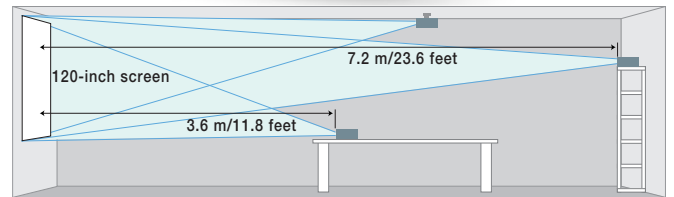

tions, this lets you accommodate a wide range of room sizes and shapes. And when replacing existing projectors, the new 2x zoom greatly expands your installation flexibility.

Wired LAN: Web Browser Control/Monitoring, E-Mail Message Alert (PT-F200NTU)

Anybody can operate the PT-F200NTU by remote control or monitor its status over a LAN network, because it is all done using the computer's familiar web browser. Furthermore, the projector sends an e-mail message to notify the operator when an error has occurred, or a lamp needs to be replaced.

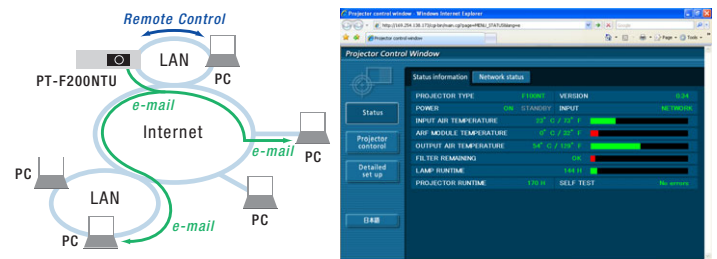

PJLink™ compatibility (PT-F200NTU)

The LAN terminals support PJLink™ class 1 connection. Control with the same specifications is also possible when used in a multi-projector system with projectors of another brand.

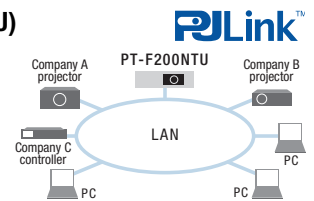

Direct Power Off

Because the cooling fan keeps operating until the lamp is cooled, you can turn off the room's main power without waiting for the projector to cool down.

Easy Lamp Replacement from the Rear

For easier maintenance, you can replace the lamp from the rear. The lamp is easily replaced even after the projector is installed on the ceiling.





The front panel covers the lens to keep it clean from dust, and conceals the controls to prevent accidental misoperation. It can be opened for easy access to controls even after the projector is installed on the ceiling.

Abundant connection terminals

Designed for versatility, each projector comes equipped with a host of connection terminals. The RS-232C specifications are the same as in previous Panasonic models, so replacement is quick and easy.

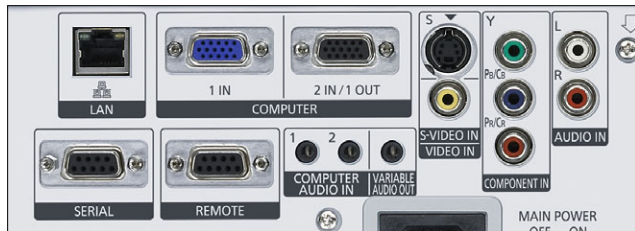

The PT-F200NTU features a LAN connector terminal.

Easy-to-Use Remote Control with Laser Pointer

The supplied remote control features a number of wireless projection controls, including Microsoft® PowerPoint® page up/down capability*. The control range and distance have been extended, and the buttons are now larger and easier to use.

* For the PT-F200NTU only.

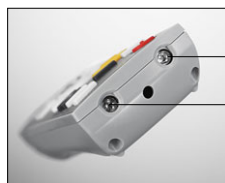

Equipped with two transmitters for an extended remote control range.



Ecology-Conscious Design

Panasonic works from every angle to minimize environmental impact in the product design, production and delivery processes, and in the performance of the product itself over its life cycle. The PT-F200 Series reflects the following ecological considerations.

- Lead-free solder is used to mount components to the printed circuit boards.
- No halogenated flame retardants are used in the cabinet.
- No styrofoam is used in the packing materials.
- Lead-free glass is used for the lens.
- The packing case and operating manual are made from recycled paper.

tion. You can make the settings for wireless connection quickly and easily using Wireless Manager ME 4.5 software. When the presentation is finished, Wireless Manager restores the PC to its previous LAN settings, so the PC is ready to reconnect to your LAN. Functions include Live mode and Multi-Live mode. In Live mode, the image projected is identical to the image seen on the PC screen. In Multi-Live mode, you can wirelessly connect with multiple PCs.

Virtual Remote Control



The same graphics used on the projector's remote control can be displayed on the PC screen. This makes it easy to operate the projector right from the PC, without having to use the remote control.

Four-window style

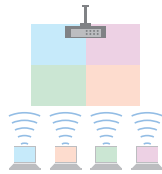

Index style (Four thumbnails)



Extended index style (16 thumbnails)

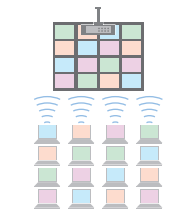

A Wide Variety of Wireless Functions

The PT-F200NTU provides a host of convenient wireless functions, including Wireless Prompter (Secondary Display Transmission), selective area transmission and a 16-window index style that lets you project images from up to 16 PCs at the same time. Wireless transmission is possible from one PC to a maximum of eight projectors at a time.

Other Valuable Features

- Built-in closed caption decoder: Displays subtitles onto the projected screen without the need for any additional device.
- Anti-theft features: Security anchor, user password, control panel lock and text superimposing
- HDTV compatibility
- Full compatibility with sRGB color space for accurate color reproduction (in natural mode)
- Picture mode selection (standard/dynamic/natural)
- Blackboard mode allows you to project images onto an ordinary classroom or conference room blackboard
- Shutter function for image/sound muting
- Selectable 17-language onscreen menu



Security anchor

WIRELESS FUNCTIONS ADD VERSATILITY (PT-F200NTU)

Easy Wireless Projection from Multiple PCs

With the PT-F200NTU's wireless capability, you don't need cables to connect a PC. That means it's easy to bring in a laptop (with a wireless LAN function) and deliver a smooth, hassle-free presenta-

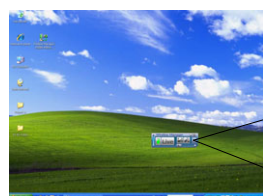

Wireless Manager Control Panel (Launcher)

To begin wireless projection, simply use the control panel (launcher) displayed in the PC window.



Specifications

Model	PT-F200NTU	PT-F200U
Power supply	100–240 V AC, 50/60 Hz	
Power consumption	330 W (Approx. 4.5 W in standby mode with fan stopped)	
LCD panel		
Panel size	0.7" (17.78 mm) diagonal (4:3 aspect ratio)	
Display method	Transparent LCD panel (x 3, R/G/B)	
Drive method	Active matrix	
Pixels	786,432 (1,024 x 768) x 3, total of 2,359,296 pixels	
Pixel configuration	Stripe	
Lens	Manual zoom (1.1–1.2), manual focus, F 1.7–2.6, f 21.6–43.0 mm	
Lamp	250 W UHM™ lamp	
Projection size	33–300 inches/838–7,620 mm diagonally (4:3 aspect ratio)	
Colors	Full color (16,777,216 colors)	
Brightness*1	3,500 lumens	
Center-to-corner uniformity*1	80%	
Contrast ratio*1	400:1 (full on/full off)	
Resolution (RGB)	1,024 x 768 pixels*2	
Scanning frequency		
RGB	Horizontal: 15–91 kHz, Vertical: 50–85 Hz	
YPbPr	480i (525i): fh 15.75 kHz; fv 60 Hz 576i (625i): fh 15.63 kHz; fv 50 Hz 480p (525p): fh 31.5 kHz; fv 60 Hz 576p (625p): fh 31.25 kHz; fv 50 Hz 720/60p (750/60p): fh 45 kHz; fv 60 Hz 720/50p (750/50p): fh 37.5 kHz; fv 50 Hz 1080/60i (1125/60i): fh 33.75 kHz; fv 60 Hz 1080/50i (1125/50i): fh 28.125 kHz; fv 50 Hz	
S-Video/Video	NTSC, NTSC4.43, PAL-M, PAL60: fh 15.75 kHz; fv 60 Hz PAL, SECAM, PAL-N: fh 15.63 kHz; fv 50 Hz	
Optical axis shift*3	Vertical: ±50%, horizontal: ±32%	
Keystone correction range	Vertical: ±30°	
On-screen menu	17 languages: English, French, German, Spanish, Italian, Korean, Russian, Chinese, Japanese, Swedish, Norwegian, Danish, Portuguese, Polish, Hungarian, Czech, and Thai	
Installation	Front/rear ceiling/desk (menu selection)	
Built-in speakers	4 cm (round), x 1, 3.0 W (monaural) output power	
Terminals		
COMPUTER 1 IN	D-sub HD 15-pin x 1	
COMPUTER 2 IN/	D-sub HD 15-pin x 1	
COMPUTER 1 OUT	(input/output selectable using on-screen menu)	
COMPONENT IN	RCA pin x 3	
VIDEO IN	RCA pin x 1	
S-VIDEO IN	Mini DIN 4-pin x 1	
AUDIO IN (COMPUTER 1)	M3 (stereo) x 1	
AUDIO IN (COMPUTER 2)	M3 (stereo) x 1	
AUDIO IN (COMPONENT/	-	
VIDEO/S-VIDEO)	RCA pin (L, R) x 1	
AUDIO OUT	M3 (stereo) x 1 (variable)	
SERIAL	D-sub 9-pin x 1 (RS-232C)	
REMOTE	D-sub 9-pin x 1	
LAN	RJ-45 x 1, 10BASE-T/100BASE-TX/100BASE-T	
Power cord length	2 m (6'7")	
Cabinet material	Molded plastic (PC+ABS)	
Dimensions (W x H x D)**	432 x 124.5 x 319 mm (17" x 4-29/32" x 12-9/16")	
Weight	6.2 kg (13.7 lbs.)	
Operating environment		
Temperature	0°–40°C (32°–104°F)	
Humidity	20%–80% (no condensation)	
Wireless LAN		
Standard	IEEE802.11b/g	
Operation range*5	Approx. 30 m (98'5")	
Infrastructure mode	WPA-PSK (TKIP/AES), 128/64-bit WEP	
Ad-hoc mode	128/64-bit WEP	
Wireless Remote Control Unit		
Power supply	3 V DC (AA battery x 2)	
Operation range*5	Approx. 10 m (32.8 feet) when operated from directly in front of the signal receptor	
Dimensions (W x H x D)	48 x 163 x 24.5 mm (1-7/8" x 6-13/32" x 31/32")	
Weight	117 g (4.2 oz) (including batteries)	
Supplied Accessories	<ul style="list-style-type: none"> • Power cord • Power cord secure lock • Wireless remote control • Batteries for remote control • Safety wire rope • Wireless Manager ME 4.5 (CD-ROM) 	

*1: Measurement, measuring conditions, and method of notation all comply with ISO 21118 international standards.
 *2: Input signals that exceed this resolution will be converted to 1,024 x 768 pixels.
 *3: Shift range is limited during simultaneous horizontal and vertical shifting.
 *4: Including protruding parts. *5: Operation range differs depending on the environment.

Options



Replacement lamp unit
ET-LAF100



Replacement filter unit
ET-RFF100



Ceiling mount bracket for high ceilings
ET-PKF100H



Ceiling mount bracket for low ceilings
ET-PKF100S

Projection Distance (4:3)

Project size (diagonal)	Projection distance (L)		Height from the edge of screen to center of lens (H)
	Min (wide)	Max (telephoto)	
0.84 m / 33"	– / –	1.9 m / 6.4'	0 – 0.25 m / 0 – 0.8'
1.02 m / 40"	1.2 m / 3.8'	2.4 m / 7.8'	0 – 0.30 m / 0 – 1.0'
1.52 m / 60"	1.8 m / 5.8'	3.6 m / 11.7'	0 – 0.46 m / 0 – 1.5'
2.03 m / 80"	2.4 m / 7.8'	4.8 m / 15.7'	0 – 0.61 m / 0 – 2.0'
2.54 m / 100"	3.0 m / 9.8'	6.0 m / 19.7'	0 – 0.76 m / 0 – 2.5'
3.05 m / 120"	3.6 m / 11.8'	7.2 m / 23.7'	0 – 0.91 m / 0 – 3.0'
3.81 m / 150"	4.5 m / 14.8'	9.0 m / 29.6'	0 – 1.14 m / 0 – 3.7'
5.08 m / 200"	6.0 m / 19.8'	12.1 m / 39.6'	0 – 1.52 m / 0 – 5.0'
7.62 m / 300"	9.1 m / 29.8'	18.1 m / 59.5'	0 – 2.29 m / 0 – 7.5'

To use wireless functions, a PC is required that meets the conditions given below:

OS:	Microsoft® Windows® 2000 Professional, Windows® XP Professional, Windows® XP Home Edition, Windows Vista®, Apple Mac OS X 10.4 (Tiger) and OS X 10.5* (Leopard) *MacBook and MacBook Pro with the Intel Core 2 Duo processor only.
NOTE: Some functions are not available with Windows Vista™ and Mac OS X.	
Web browser:	Windows®: Internet Explorer 6.0 or later, or Netscape Communicator 7.0 or later. Mac OS: Safari 2.0 or later
CPU:	Windows®: Intel® Pentium® III or higher, or other compatible processor (1 GHz or higher is recommended). Mac OS X 10.4: 800-MHz or higher PowerPC G4, or 1.8-GHz or higher Intel® Core™ processor. Mac OS X 10.5: MacBook and MacBook Pro with the Intel® Core™ 2 Duo processor only.
Memory:	256 MB or more (512 MB or more is recommended for Mac)
Free hard disk space:	60 MB or more
CD-ROM drive:	CD-ROM drive or DVD drive
Wireless LAN:	IEEE 802.11b/g compatible (built-in wireless LAN system or external IEEE 802.11b/g LAN card must be installed and running normally.)
NOTE: Some IEEE 802.11g/b wireless LAN may not allow connection to the projector.	
Wired LAN connector:	RJ-45
NOTE: Use Category 5e (or higher) cables for 100BASE-T connection.	

NOTES ON USE

- The projector uses a high-voltage mercury lamp that contains high internal pressure. This lamp may break, emitting a large sound, or fail to illuminate, due to impact or extended use. The length of time that it takes for the lamp to break or fail to illuminate varies greatly depending on individual lamp characteristics and usage conditions.
- The brightness of the lamp will gradually decrease with use.
- The projector includes consumable parts. The frequency of replacement for the lamp and other consumable parts will increase if the projector is subjected to extended, continuous use. For details, please consult a service representative.

Dimensions

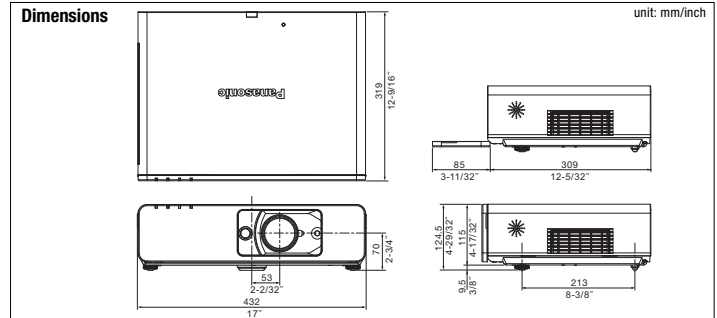

Panasonic®

Panasonic Projector Systems Company,
 Unit of Panasonic Corporation of North America
www.panasonic.com/projectors

Headquarters
 3 Panasonic Way, 4B-9
 Secaucus, NJ 07094
 888-411-1996

Panasonic Canada Inc.
 5770 Ambler Drive
 Mississauga, Ontario
 Canada L4W 2T3
 905 624 5010

Projectors Global Web Site: <http://panasonic.co.jp/pavc/global/projector>
 Please contact Panasonic or your dealer for a demonstration.



Weights and dimensions shown are approximate. Specifications are subject to change without notice. Product availability differs depending on region and country. This product may be subject to export control regulations. UHM is a trademark of Matsushita Electric Industrial Co., Ltd. Intel and Pentium are registered trademarks of Intel Corporation. Windows is either a registered trademark or trademark of Microsoft Corporation in the United States and/or other countries. All other trademarks are the property of their respective trademark owners. Projection images simulated. (C) 2006 Panasonic Projector Systems Company is a Unit Company of Panasonic Corporation of North America. All rights reserved. (C) 2006 Matsushita Electric Industrial Co., Ltd. All rights reserved.

All information included here is valid as of January 2008.

PT-F200NTU1-08JAN30K Printed in Japan.